

25°

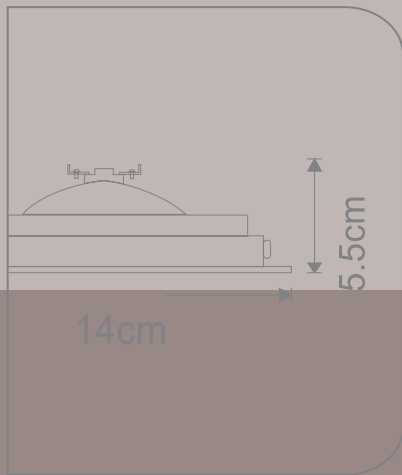

MULTI / COMBI

Recessed Combined Downlight

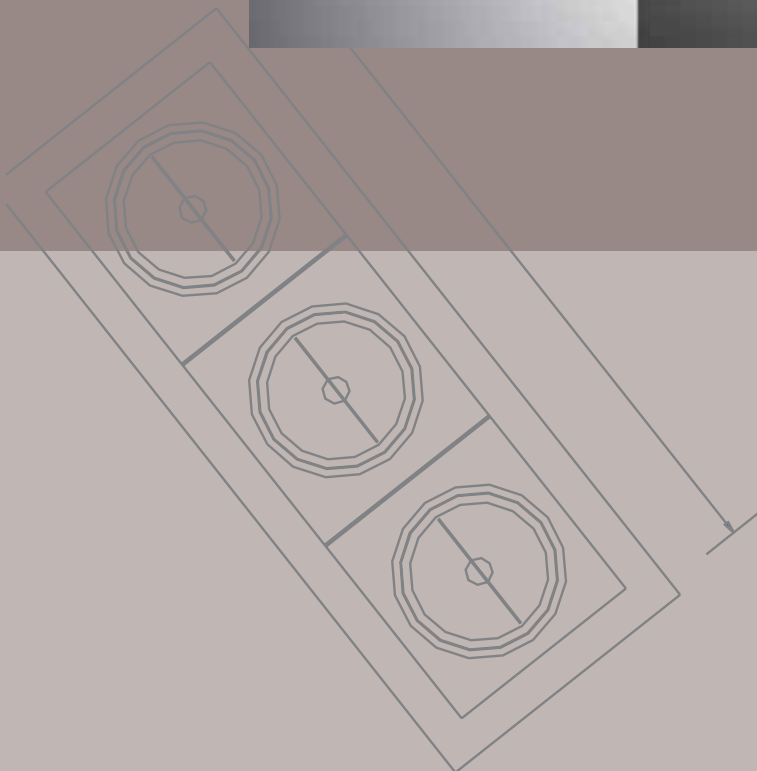

COMBI

Recessed Combined Downlight



Combi recessed down light is designed for direct focusing spot fitting, adapt to QR111, CDM-T, CDM-T, CDM-R, PAR30 and T-CD lamp Combi installation plate and the angling can be adjusted individually.



CCM-1180-WH

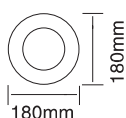
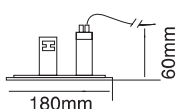

CCM-1180-WH

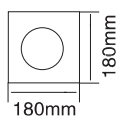
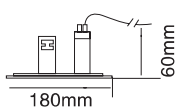

CCM-2180-WH

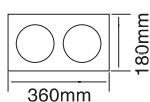
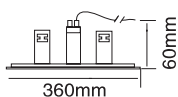

CCM-3180-WH

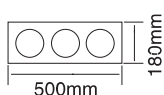
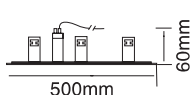

CCM-4180-WH

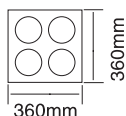
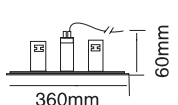

To be completed with below different types of lamps and fixtures



SP-C5-CDMR/PAR30
MAX 70W CDM-R/PAR30



SP-C5-PAR30
MAX 70W PAR30



SP-C5-COMT
MAX 150W CDM-T G12



SP-C5-TCD
13W TC-D G24d-1



SP-C5-111
MAX 100W QR111 G53

MINI COMBI

Recessed Combined Downlight

Complete with one to three linear mounting plate used to support single or multiple projectors to illuminate horizontal surface, mounting plate and projector are made by high density aluminium treated with heat resistant painting. Deep recessed light source, no glare on ceiling.



CMM - 1108 - WH

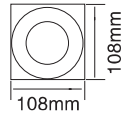
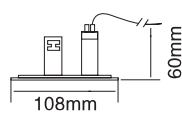

CMM - 1108 - WH

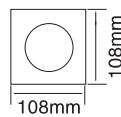
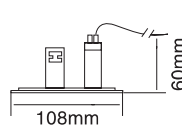

CMM - 2108 - WH

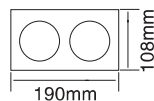
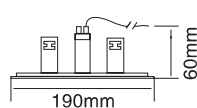

CMM - 3108 - WH

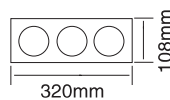
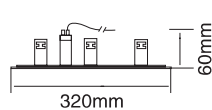

To be completed with below different types of lamps and fixtures

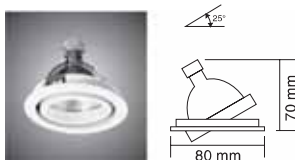

SP-MR16-1
MAX QR-CB51 50W 12V GU5.3

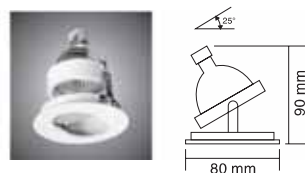

SP-MR16-2
MAX QR-CB51 50W 12V GU5.3

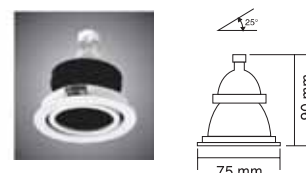

SP-MR16-3
MAX QR-CB51 50W 12V GU5.3

MULTI AR

Recessed Combined Downlight



Recessed down light is designed for direct focusing spot fitting, adapt to QR111. The fitting is made of extrusion aluminium and metal for stamping, suits for interior commercial lighting.



MUA-5021 QR111 50W G53

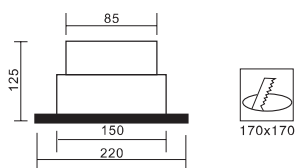

Available On Request

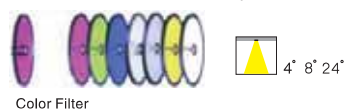

MUA-5022 QR111 50Wx2 G53

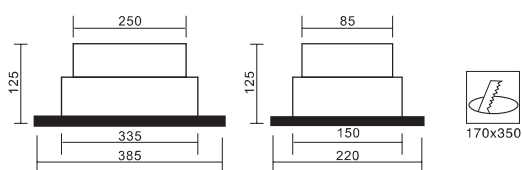

Available On Request

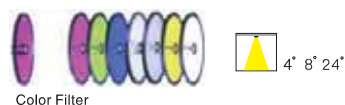

MUA-5023 QR111 50Wx3 G53

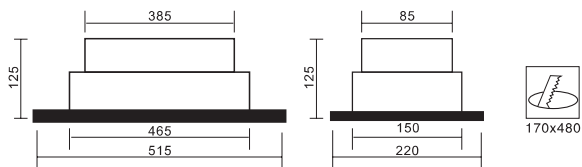

Available On Request

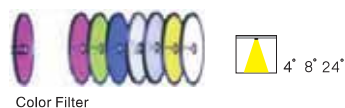

Completed with 12V transformer

MULTI MR

Recessed Combined Downlight

Recessed down light is designed for direct focusing spot fitting, adapt to MR16. The fitting is made of extrusion aluminium and metal for stamping, suits for interior commercial lighting.



MUM-5111 MR16 50W GU5.3

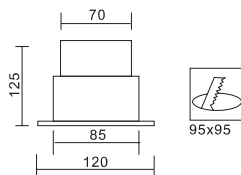

MUM-5112 MR16 50Wx2 GU5.3

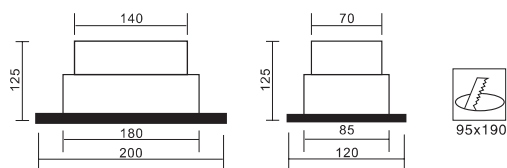

MUM-5113 MR16 50Wx3 GU5.3

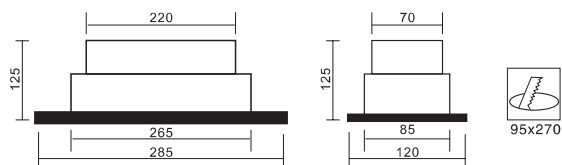

Completed with 12V transformer

MULTI MR

Recessed Combined Downlight



Recessed down light is designed for direct focusing spot fitting, adapt to MR16. The fitting is made of extrusion aluminium and metal for stamping, suits for interior commercial lighting.



MUM-5121 MR16 50W GU5.3

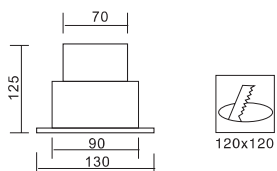

MUM-5122 MR16 50Wx2 GU5.3

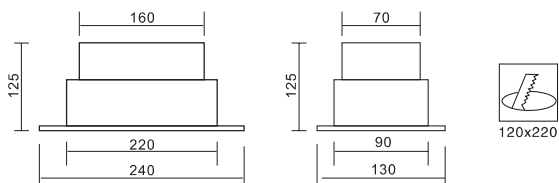

MUM-5123 MR16 50Wx3 GU5.3

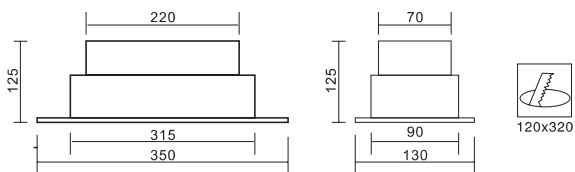

Completed with 12V transformer

MULTI MR

Recessed Combined Downlight

Recessed down light is designed for direct focusing spot fitting, adapt to MR16. The fitting is made of extrusion aluminium and metal for stamping, suits for interior commercial lighting.



MUM-5131 MR16 50W GU5.3

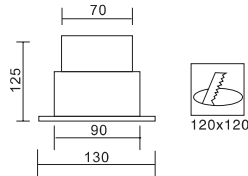

MUM-5132 MR16 50Wx2 GU5.3

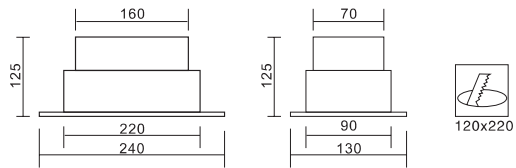

MUM-5133 MR16 50Wx3 GU5.3

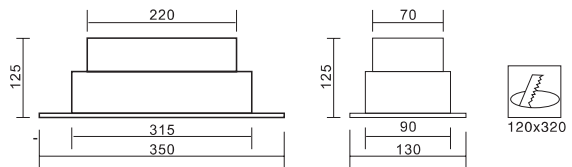

Completed with 12V transformer

The Multi Combi is a suspension fixture which has been developed as a luminaire with a combination of general and accent lighting. The QR111 or HIT lamps are surrounded with circular or compact fluorescent lamps. Besides the suspended version, there is also a possibility for direct fixation onto the ceiling with the Multi Combi recessed version and surface mounted version.



MUC-01R
QR111 Max 50W G53
T5-FC 55W G10q

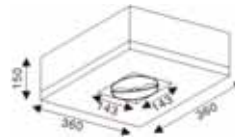

MUC-02R
HIT Max 70W G12
T5-FC 55W G10q

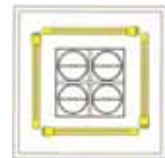
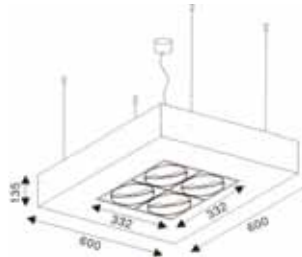

MUC-03P
QR111 Max 50W x4 G53
TC-L 36Wx4 2G11

MUC-04P
HIT Max 70Wx4 G12
TC-L 36Wx4 2G11

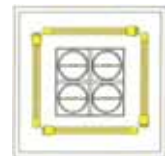
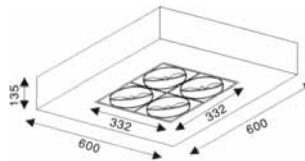

MUC-03R
QR111 Max 50Wx4 G53
TC-L 36Wx4 2G11

MUC-04R
HIT Max 70Wx4 G12
TC-L 36Wx4 2G11