



063

1-1-19

A large, rectangular green panel is mounted on a wall. On the left side of the panel is a black fleur-de-lis symbol. To the right of the symbol is a list of numbers arranged in approximately 15 rows. The numbers appear to be a sequence of digits, possibly representing a code or a list of identifiers. The panel is set against a dark background, and the lighting is somewhat dim, creating a somber atmosphere.

# ***LINEAL WET***



# LINEAL WET



**WLS-5814**  
**WLS-5814-2**  
 T5 14W x1, x2  
 G5  
 L=600mm  
 3.9Kg

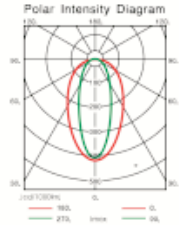

**WLS-5821**  
**WLS-5821-2**  
 T5 21W x1, x2  
 G5  
 L=900mm  
 4.7Kg

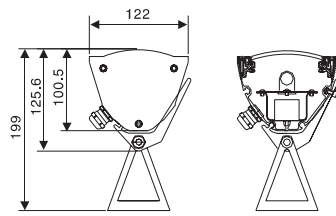
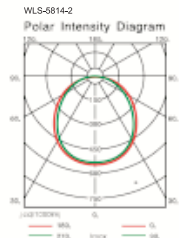

**WLS-5828**  
**WLS-5828-2**  
 T5 28W x1, x2  
 G5  
 L=1200mm  
 5.5Kg

**WLS-5835**  
**WLS-5835-2**  
 T5 35W x1, x2  
 G5  
 L=1500mm  
 6.3Kg

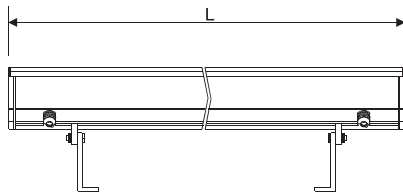

**WLS-5854**  
**WLS-5854-2**  
 T5 54W x1, x2  
 G5  
 L=1200mm  
 5.5Kg



Vertical anti-glare grid



Horizontal anti-glare grid

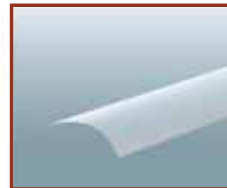

Clear PC diffuser



Sand-blasted PC difuser



Wall-Mounted

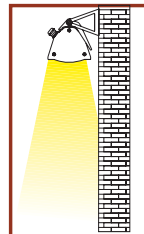

Pendant-Mounted

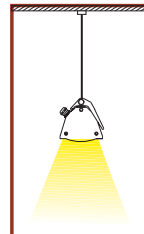

Free Standing

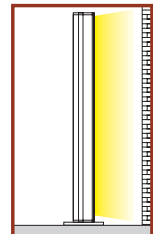



**WLA-5814-AS**

T5 14W  
G5  
L=600mm  
3.9Kg

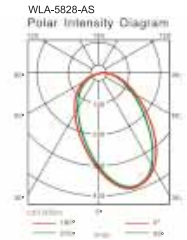

**WLA-5821-AS**

T5 21W  
G5  
L=900mm  
4.7Kg

**WLA-5828-AS**

T5 28W  
G5  
L=1200mm  
5.5Kg

**WLA-5835-AS**

T5 35W  
G5  
L=1500mm  
6.3Kg

**WLA-5854-AS**

T5 54W  
G5  
L=1200mm  
5.5Kg

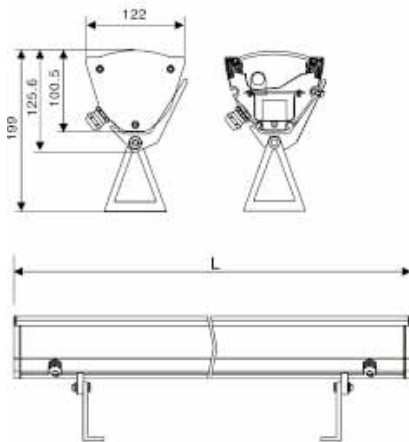

**Asymmetrical Reflector**

Partial sand blasted difuser for reducing glare



# GROUND LINEAL WET

## Symmetrical / Asymmetrical



- In-ground is installed
- Housing combined die cast and extrusion aluminium
- Stainless steel cover frame
- 12mm temper glass with high vandal resistance
- BODYGUARD—7-YEAR FINISH WARRANTY
- T5 Fluorescent lamp, various length available.
- Pure aluminium reflector. Asymmetrical & Symetrical reflector.
- Protection: IP67. 3000 Kgs pressure resistance.
- Good for out door liner flood lighting. Facade lighting. Wall-washing.

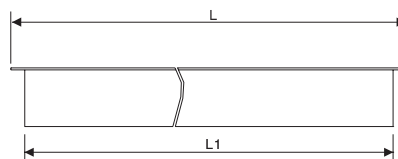
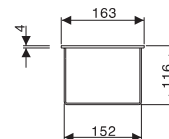

**GWL-5814-R**  
T5 14W  
G5  
L=665mm  
L1=610mm  
3.9Kg

**GWL-5828-R**  
T5 28W  
G5  
L=1265mm  
L1=1210mm  
5.5Kg

**GWL-5814-RAS**  
T5 14W  
G5  
L=665mm  
L1=610mm  
3.9Kg

**GWL-5828-RAS**  
T5 28W  
G5  
L=1265mm  
L1=1210mm  
5.5Kg

**GWL-5821-R**  
T5 21W  
L=965mm  
L1=910mm  
4.7kg

**GWL-5854-R**  
T5 54W  
L=1265mm  
L1=1210mm  
5.5kg

**GWL-5821-RAS**  
T5 21W  
L=965mm  
L1=910mm  
4.7kg

**GWL-5854-RAS**  
T5 54W  
L=1265mm  
L1=1210mm  
5.5kg

**GWL-5824-R**  
T5 24W  
L=665mm  
L1=610mm  
4.1kg

**GWL-5824-RAS**  
T5 24W  
L=665mm  
L1=610mm  
4.1kg



Symmetrical Reflector

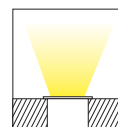
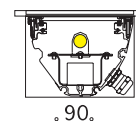
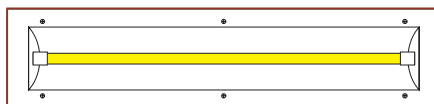

Asymmetrical Reflector

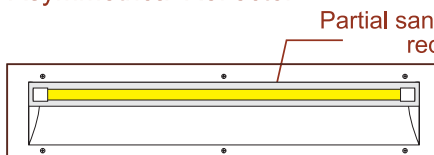

Partial sand blasted diffuser for reducing glare

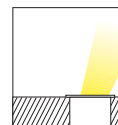
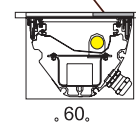

Smart outlook design with compact and firmness structure

Aluminium die-casting end cap and anodized extrusion housing.

Special design of "clip on" system guarantee.

IP rated and easy maintenance.

IP66 protection, with silicon gasket.

Adjustable illuminating angle for diverse mounting, like horizontal, vertical, pendant mounting...

Applicable for outdoor and indoor lighting of architecture, bridge and wall washing. Etc.



**TUF-5814B**

T5 14W L-600  
2.2 Kg

**TUF-5835B**

T5 35W L-1500  
5 Kg

**TUF-5821B**

T5 21W L-900  
3.2 Kg

**TUF-5854B**

T5 54W L-1200  
4.2 Kg

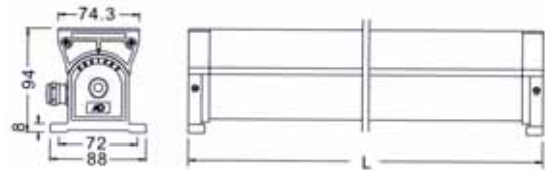

**TUF-5828B**

T5 28W L-1200  
4.2 Kg

**TUF-5828B 28W**

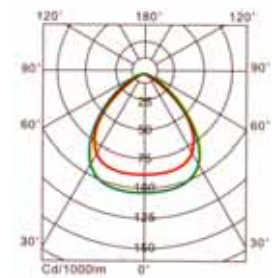

Accurate casting angle adjusting and locking function, can adjust maximum 45° (both sides)

Special design of "clip on" system guarantee IP rated and easy maintenance.





# ***FUSION LINEAL***

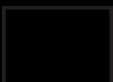

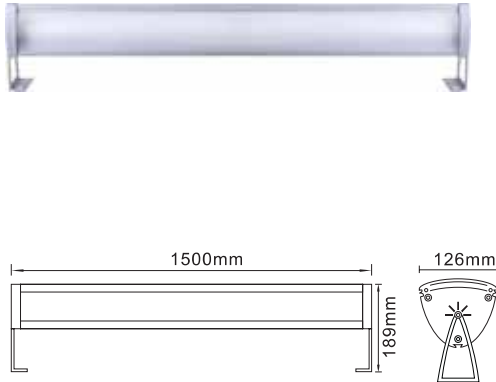

**FL-5835-3C**  
 (Wall Mounted)  
 (Lamp)  
 T5 HF 35W in Red, Green & Blue  
 (Life expectancy)  
 20,000 Hours  
 AC Power (normal tension)  
 220V 50Hz  
 (Dimming control)  
 1-10V  
 (Maximum power and current)  
 0.45A/105W  
 (Maximum Te.)  
 40°C

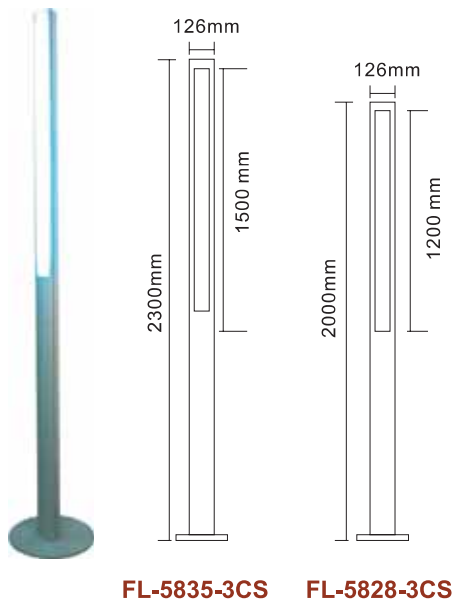

**FL-5835-3CS    FL-5828-3CS**

**FL-5828-3Cs**  
 (Free Standing)  
 (Lamp)  
 T5 HF 28W in Red, Green & Blue  
 (Life expectancy)  
 20,000 Hours  
 AC Power (normal tension)  
 220V 50Hz  
 (Dimming control)  
 1-10V  
 (Maximum power and current)  
 0.36A/84W  
 (Maximum Te.)  
 40°C

**FL-5835-3Cs**  
 (Free Standing)  
 (Lamp)  
 T5 HF 35W in Red, Green & Blue  
 (Life expectancy)  
 20,000 Hours  
 AC Power (normal tension)  
 220V 50Hz  
 (Dimming control)  
 1-10V  
 (Maximum power and current)  
 0.45A/105W  
 (Maximum Te.)  
 40°C

Colour changing effect by RGB mixing technology

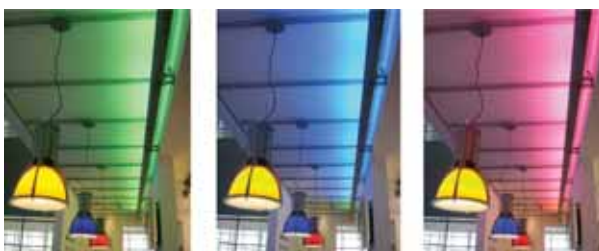

Clear PC diffuser



Sand-blasted PC diffuser

